

Journey to IPv6 A Real-World deployment for Mobiles

APRICOT 2017 – February 2017



Introduction

Jeff Schmidt- Technology Team Manager, Telstra Wireless
Network Engineering

Managing the Technical Lead for Wireless IPv6 deployment and
Wireless Mobile IP Edge/Core Architecture



Agenda

1. **Why IPv6?**
2. **Business and Technical considerations**
3. **Network Architectures**
4. **Addressing and Subnetting**
5. **Deployment Model**
6. **Our Experience**
7. **Q&A**



Why IPv6?



Why IPv6?

Traffic growth and device per person

Network readiness for new technologies:

- Internet-of-Things
- VoLTE/IMS
- ViLTE
- Management and Backhaul

IPv4 public/private address depletion

Reduction in network inefficiencies



IPv6 Global Traffic

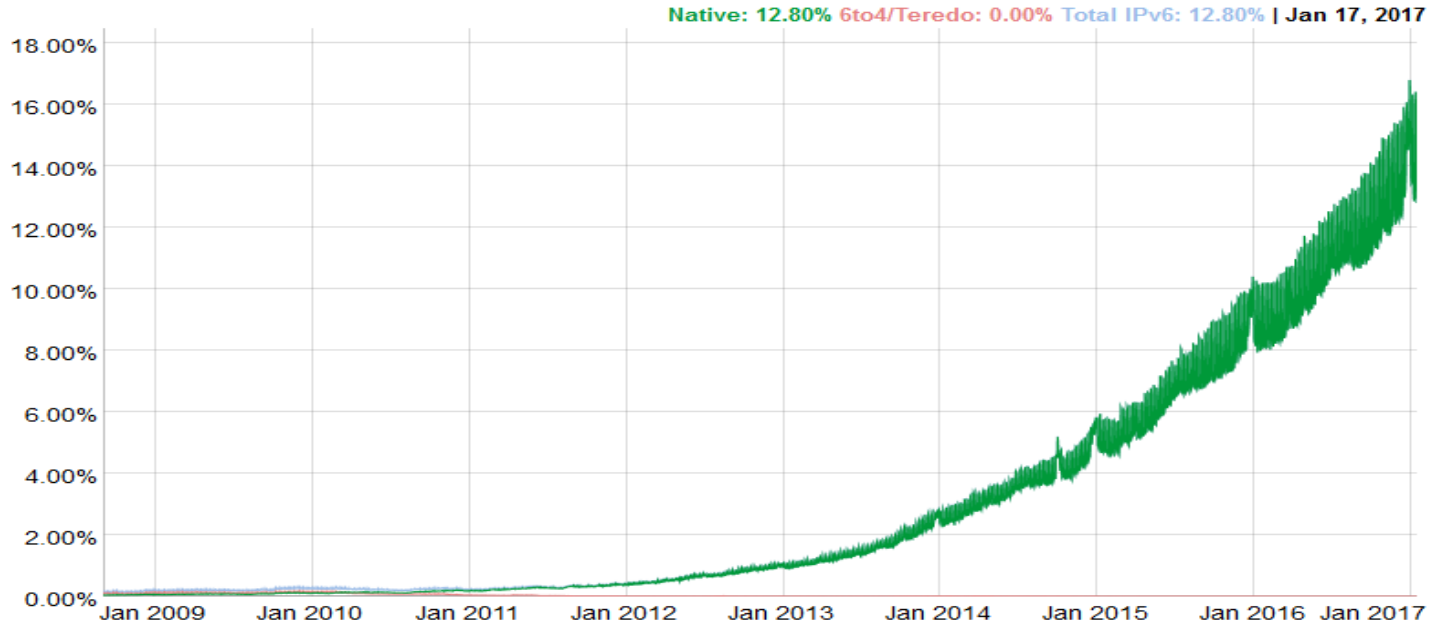

Source - <https://www.google.com/intl/en/ipv6/statistics.html>



Business and Technical Considerations



Business and Technical Considerations

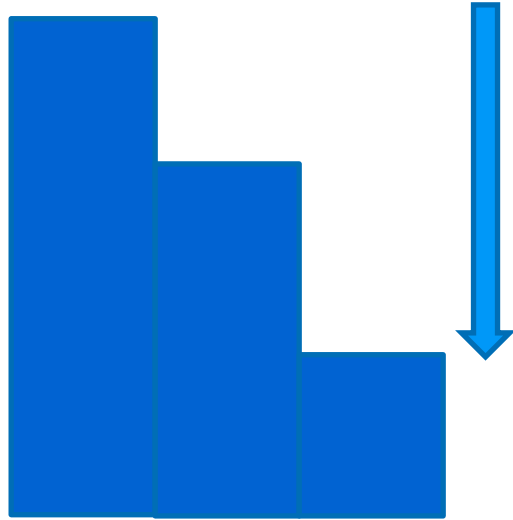

Depleting public and private IPv4 address range



Business and Technical Considerations

Non-interworking private IPv4 address ranges duplicated between domains, that now require interworking

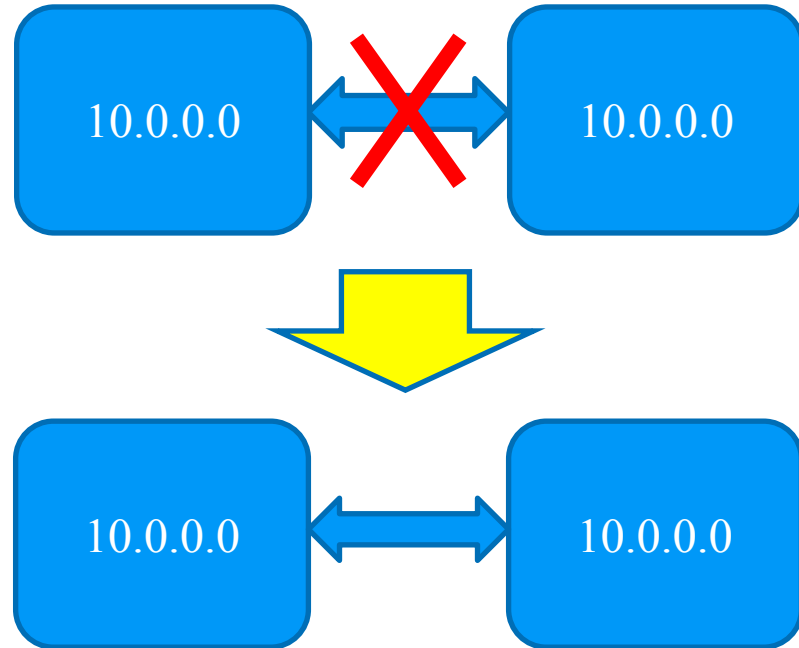

Business and Technical Considerations

Continual investment to
extend IPv4 resources vs IPv6
to future proof our network

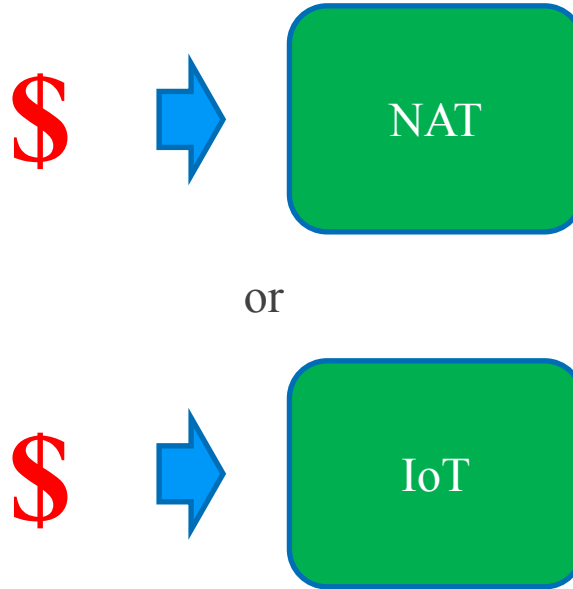

Business and Technical Considerations

As IPv4 addresses deplete, it will be more expensive to extend IPv4 resources

Dual-Stack is an effective transition technology but does not solve the IPv4 depletion problem

Introducing IPv6:

- Reduced dependency on NAT
- Remove the need for regionalisation
- Pushes applications to move to IPv6



Network Architectures



IPv6 Implementation

Centralised CGN

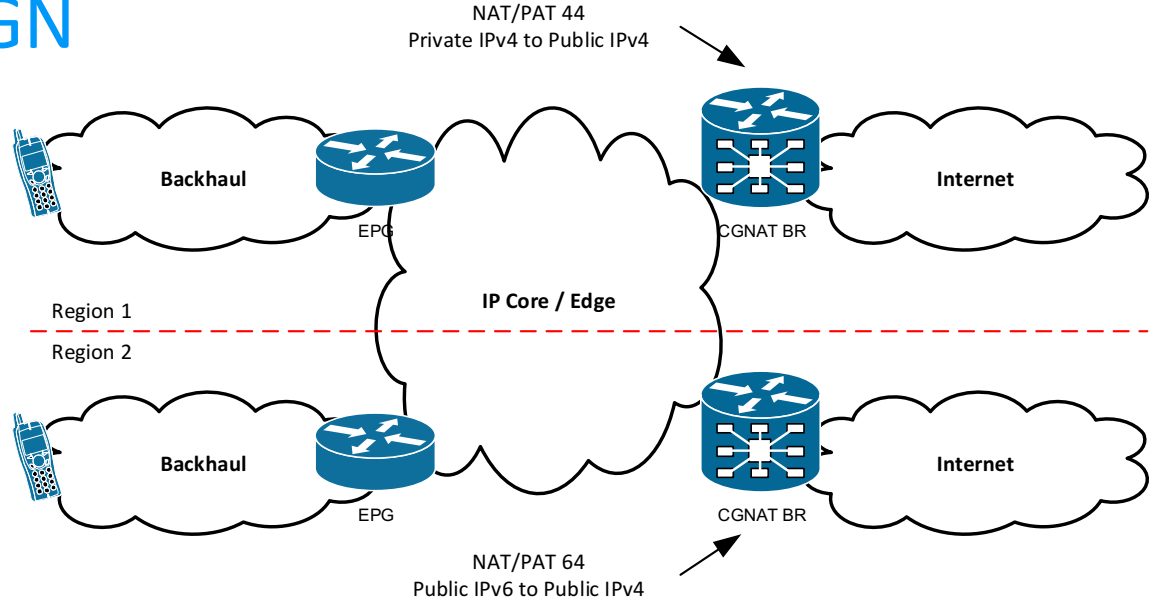

- CGN performs NAT/PAT 44 and NAT/PAT 64
PAT substantially reduces Public and Private IPv4 address demand, but does not prevent IPv4 address depletion.



IPv6 Implementation Traffic Flow

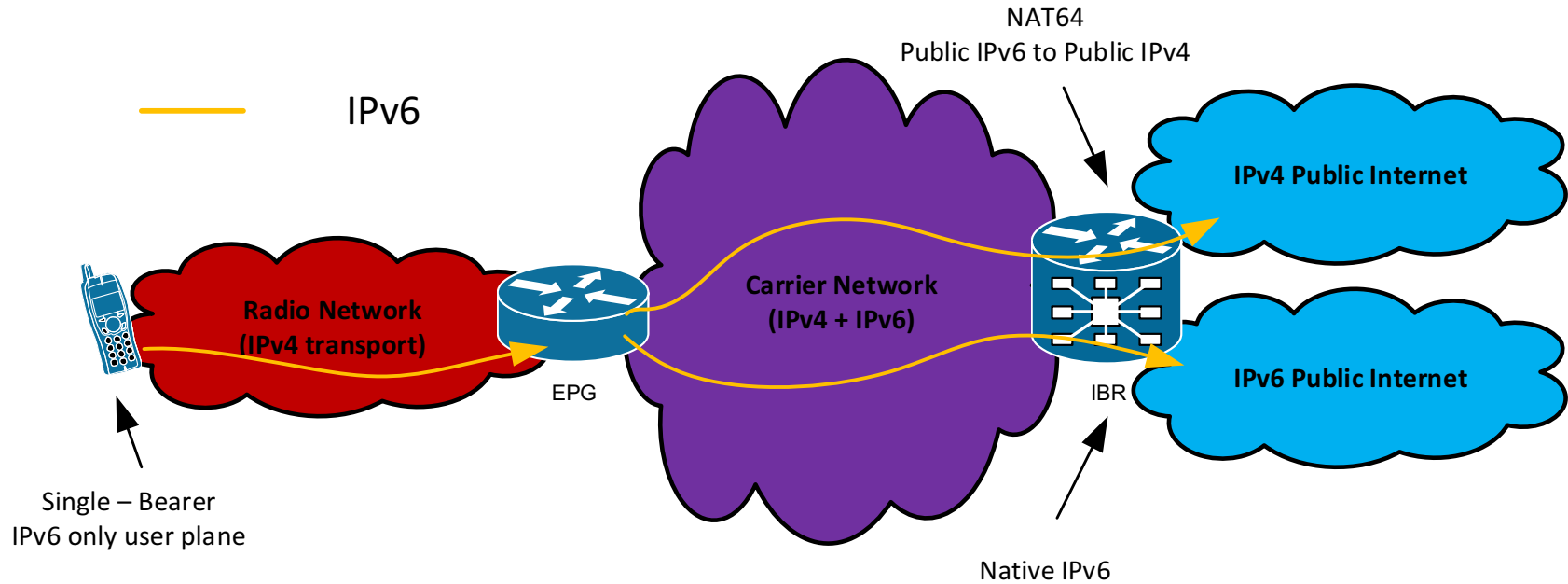

Running multiple APNs

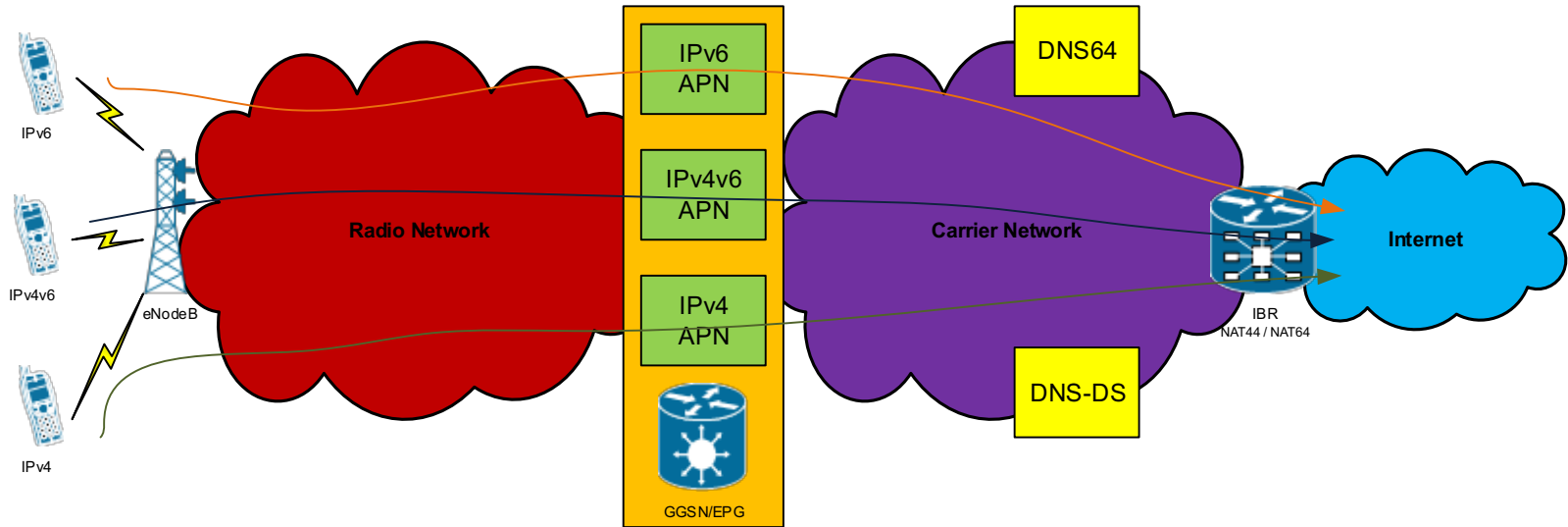

Create multiple real APNs that supports IPv4, IPv6, and IPv4v6 individually



Running a Single APN

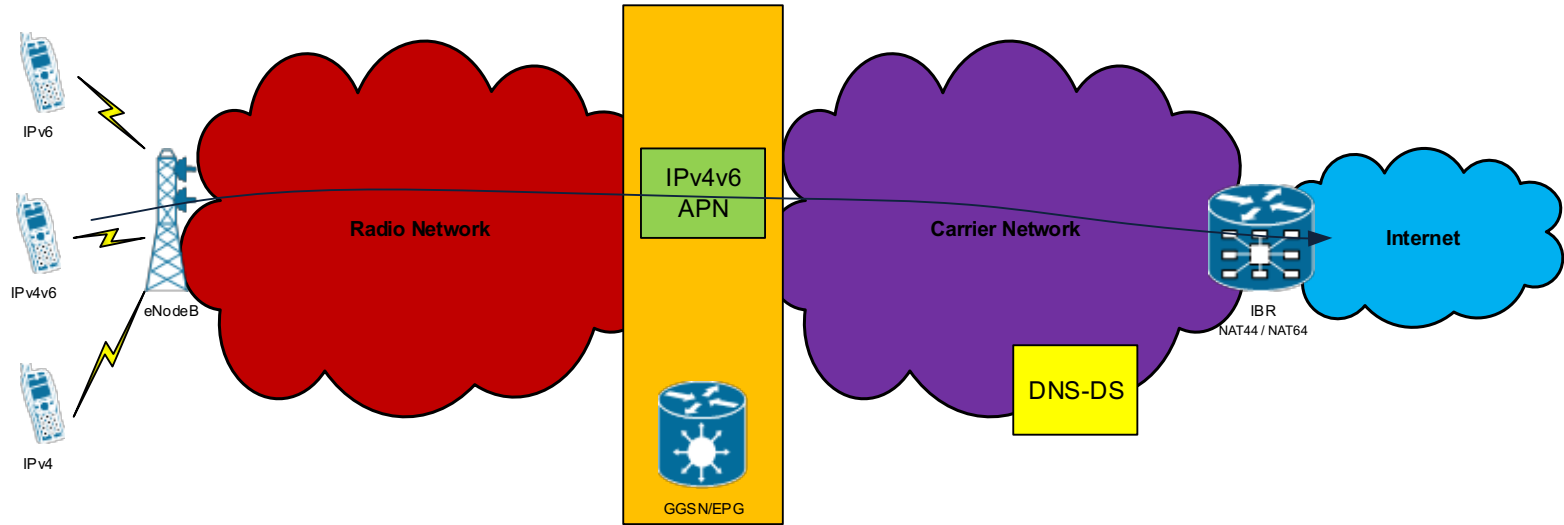

Create a single real APN that supports both DS and SS



IPv6 Implementation Security

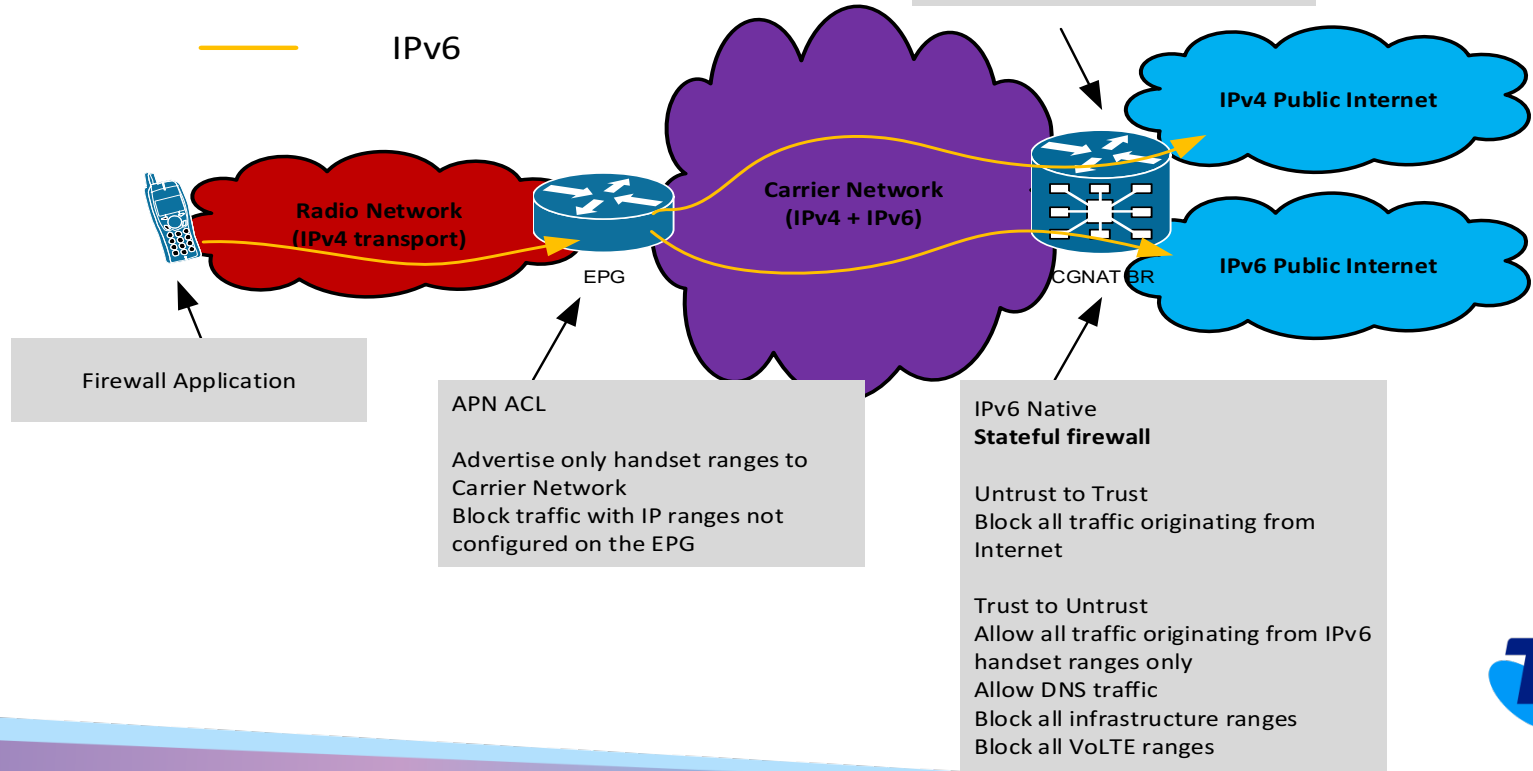

Infrastructure Cloud IPv6

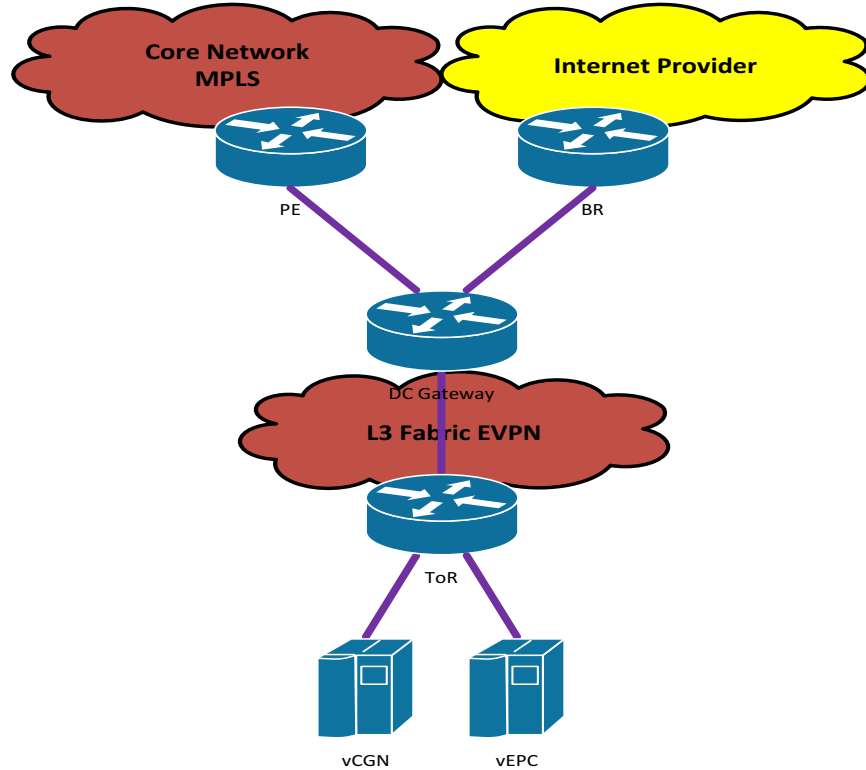

How much traffic will use IPv6?

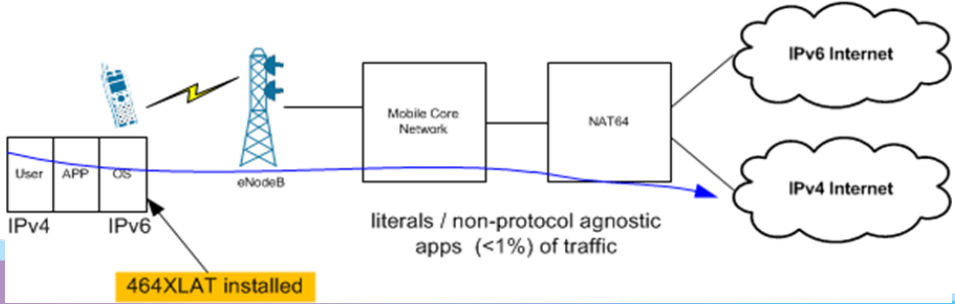
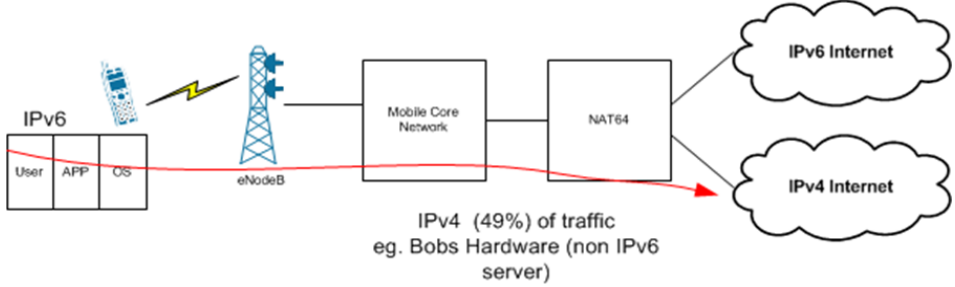
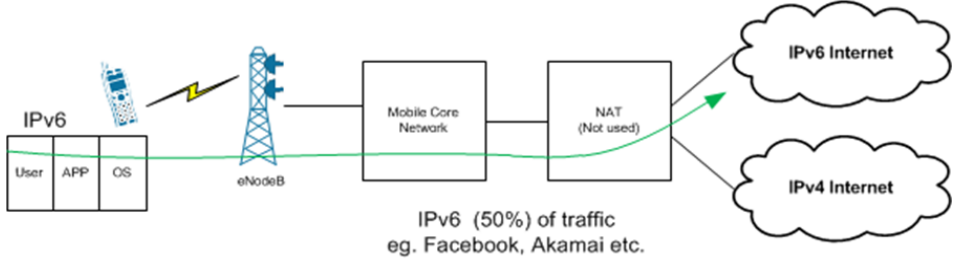

464XLAT Architecture for Mobiles

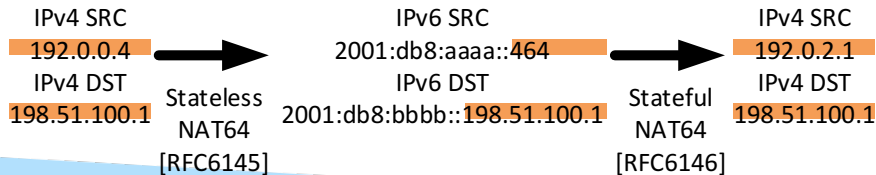
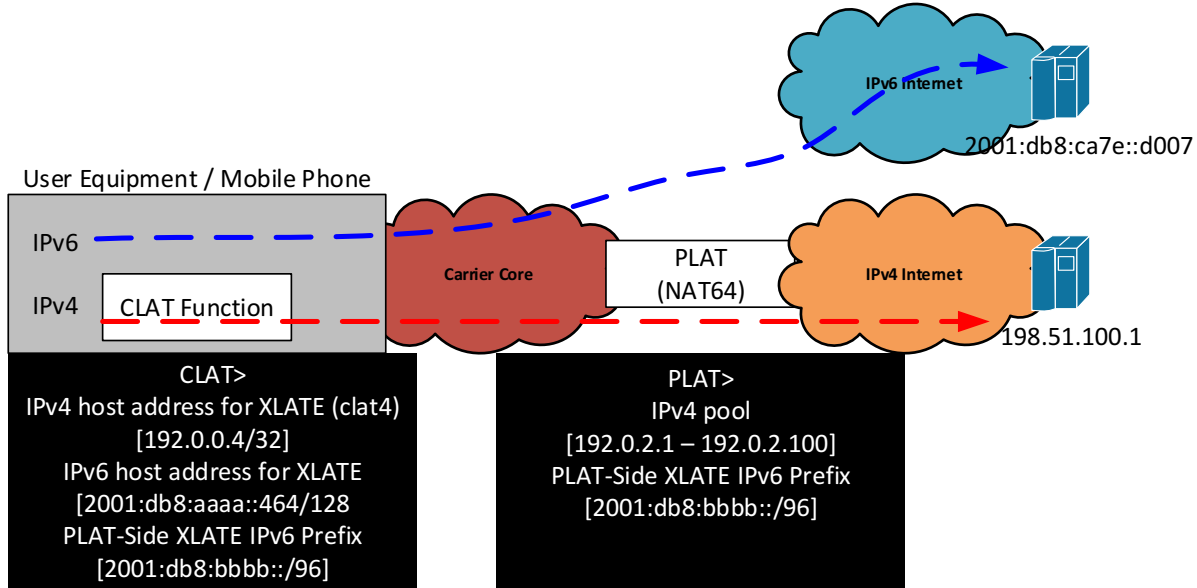

Addressing and Subnetting



Addressing and Subnetting

3GPP currently dictates each UE to receive a /64

Future releases may require a /60 with DHCP-PD for single APN tethering

4x /44 per APN per EPG = 4M prefixes

You will probably also need a similar range for VoLTE APNs

KEY: make sure it is a structured subnetting schema so it is consistent nationally and across the entire organisation.



Addressing and Subnetting

Infrastructure Addressing:

/64 per VLAN – Keep it simple!

Private or Public – but remember to use a firewall and policies to avoid advertising the infrastructure out to the internet!

NAT is not a security feature!



Deployment Model



Carrier Examples

SP1

SP2 / SP3

SP4

Dual-Stack SS+NAT64+DNS64+CLAT SS/DS+NAT64+DNS-HD+CLAT

1. Every carrier will have a unique set of circumstances that dictates which transition method they will use. There is no standard way of doing this.
2. You must determine which is the best method for your network.

In any method, remember to ensure you have a long-term strategy for the eventual deployment of native Single Stack IPv6!



Different APNs for different purposes

Two existing APNs – one for Handsets, one for Mobile Broadband and Tethering



464XLAT + NAT64 + DNS64 for the Handset APN only

IPv6 enabled DNS for all other APNs



Packet Core Configuration

HSS Configuration

PDP Context id = IPv4v6

MME Configuration

DAF = set

EPG Configuration

PDPTYPE = IPv4v6

EPG will then also have the following as a minimum within each APN:

-IPv6 Handset Range

-IPv4 Handset Range

-2x IPv4 DNS Name Servers, 2x IPv6 DNS Name Servers



UE Requirements and Settings

Android 4.3+ supports 4G/LTE. We recommend using anything that is 4.4.4+ or 5.1+

Depending on your setup, either PDP selection is based on the UE or the Network.

International Roaming over IPv6 works today! But we recommend the APN Roaming Protocol to be set to IPv4 only for the next two years.



Launch Considerations

- **Informed Front of House and provided training, as well as Enterprise support and sales personnel**
- **Updated internal Knowledge Base**
- **Briefed Operations and provided training**
- **Created moderated forum with official details on the network change**
- **Provided direct email contact to Telstra Engineering**
- **Contacted the technical community via mailing lists and public forums before launch**



Our Experience



Our Experience

iPad Dual-Stack Carrier Settings

Significant IPv6 takeup on iPads since carrier update was made available with Dual-Stack.

Update made via iOS patch. Users are not immediately aware IPv6 is available on their iPads. Transparent migration.

IPv6 take up occurs when iPads are patched to the latest version

Single Stack will come later this year



Our Experience

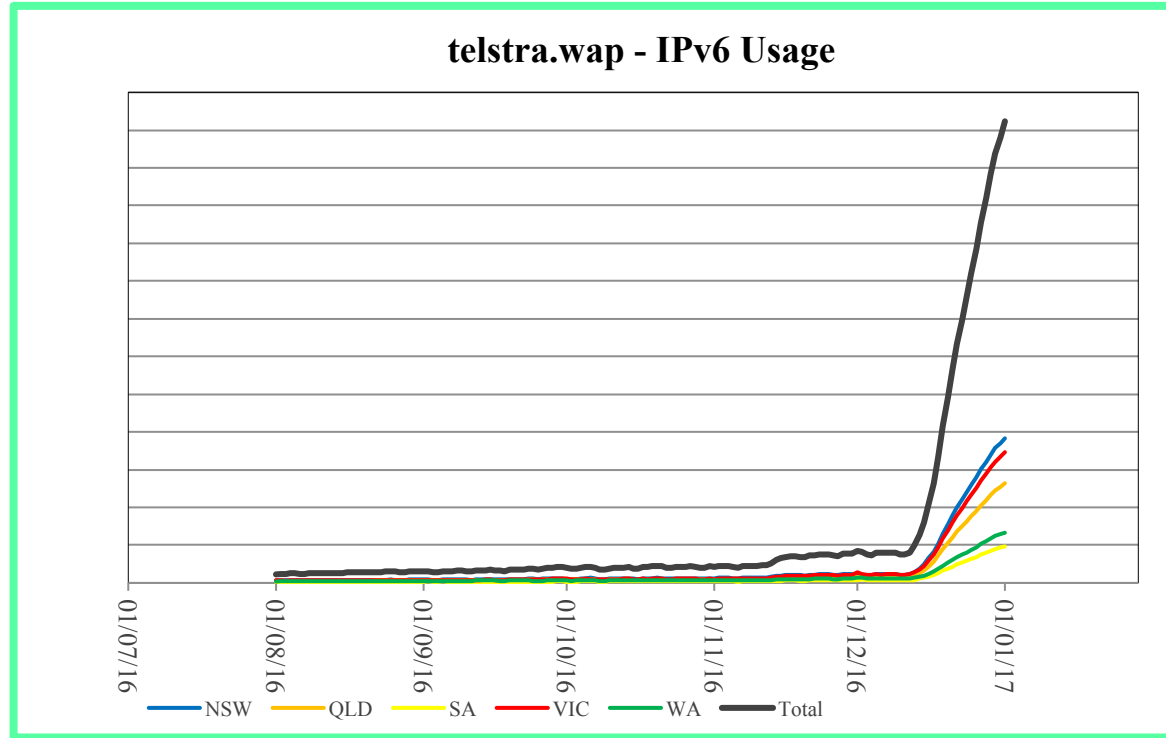

BYO device and existing services

APN – IPv4v6, HLR/HSS – IPv4v6

Legacy devices configured with IPv4 only are not impacted

New devices configured with IPv4v6 obtains both addresses and is currently growing significantly

Existing devices configured with IPv6 only obtains IPv6 only

CGNAT

NAT64 ALGs: ftp, sip, pptp, rtsp, h323



IPv4 vs IPv6

Some applications fail with IPv6 – even with 464XLAT. Routing issues?

VPNs are a real problem – but is it a carrier problem or an application / server problem?

HTTP / HTTPS works very well

SSH is not a major problem

IPv6 is faster in some cases – smaller BGP table, no NAT etc.

Major apps work very well – especially from the major content providers



Customer Support

Engage the community early so they know what's coming. They will appreciate you are still developing and they will want to be part of the journey!

We receive support email through our contact points and reply as soon as possible. Don't keep your customers waiting

Skip the red tape – let customers engage engineering directly

Keep management happy! Report SIO and bandwidth usage!



Q&A



CONTACT



Contact

Jeff Schmidt

Technology Team Manager
Telstra Wireless Network Engineering

jeff.schmidt@team.telstra.com

Sunny Yeung

Senior Technology Specialist
Telstra Wireless Network Engineering

sunny.yeung@team.telstra.com

